



Pre-Paint>Fuselage>Prepare the fuselage

Issue Revision Table

Issue	Date:	Change(s):	Issued by:
1			
2	Nov 2021	Adopt "Section Only" Manual System, Add Issue Revision Table and model applicability. Updated photos showing Vertical Fin Bulkhead Add Cabin Air Vent assembly drawing 3A069A0D-1	AS SW

Model Applicability

Aircraft Model	J-160	J-170	J-230	J-430
Document Applicability			Yes	Yes

This document is controlled while it remains on the Jabiru server. Once this no longer applies it becomes uncontrolled.

Issue:	0	1	2							Issued by: AS	Page: 1 of 8 11 November 2021
--------	---	---	---	--	--	--	--	--	--	---------------	-------------------------------



Pre-Paint>Fuselage>Prepare the fuselage> Procedure

Objectives of this task:

Once the *Underbody penetrations* and *Fit ventral fin and trim horn* tasks have been completed the fuselage can be turned upright and the remaining penetrations made. This allows the bulk (but not all) of the mess to be made early in the build.

In the factory we place the fuselage in a jig at this stage, however you can achieve much the same result by placing a sawhorse or a similar platform or trestle under the cabin and a higher trestle under the empennage. Cover both of these items with some padding to minimise scratching the fuselage.



Large holes should be started with a pilot hole first to accurately place the hole and then be drilled out with a hole saw. Slots should have each end drilled out first and then mark and use a jigsaw to join the holes. Rectangular holes should have a hole drilled at each corner and then be marked and cut from hole to hole with a jigsaw. This practise will ensure accurate cuts with no sharply angular corners or irregular edges.

Materials and tools required:

- 4 lengths of 32mm OD grey plastic conduit, each 150mm long
- Resin and flock, superglue, 5-minute Araldite and flock
- Power drill with bits and hole saws in various sizes, jigsaw
- Orbital sander, sanding blocks and 80-grit sandpaper

Sand the fuselage

Start by using your orbital sander to take any rough edges away: the moulding process can leave sharp edges and the occasional few glass fibre prickles, so take a bit of time now and remove all of these potential hand hazards before starting work. Fibreglass cuts are painful and you can do a lot to avoid them by careful preparation at this early point in the build.

Think of it as an investment in your comfortable building future. Run your orbital sander lightly across every internal surface: around the door frames, seats, console, windows, etc and anywhere else that looks even slightly rough. There is no need to sand heavily; just a light scuff is all that is required. Use a few hand sanding blocks for any hard-to-get-at places.

Superglue the rudder grommet in place

This is a simple thing that can save a lot of trouble later: put a few drops of superglue under the lip of the rubber grommet (circled at right, as viewed from the cabin) where the rudder cable will pass into the ventral rib.



When you fit the rudder cable there is a possibility that the grommet could be dragged into the ventral rib, so take a few minutes now and prevent that from happening.

Use a screwdriver to lift up the edges of the grommet and put at least 6 drops of superglue under it.



Access is from the cabin and the fit will be tight but this is well worth the small amount of effort that is required.

Remove peel cloth

Remove the peel cloth from the vertical fin stub and around the rear of the empennage generally, including around the horizontal stabiliser opening. Lightly sand around the edges of the areas under the peel cloth to remove any peel cloth threads that remain.

Vertical fin stub Cut-outs

The rudder cable passes from the empennage and through the fin stub as does the static line, VHF antenna cabling and strobe wiring (if you elect to have a tail strobe). All these items require access into and through the fin stub.

Start by marking and cutting the rudder cable slot on the right-hand side of the fin stub: measuring from the rear of the stub the slot starts at 140mm and finishes at 210mm. The slot is located half way up the stub. Drill each end of the slot to 15mm and jigsaw the slot out, and then sand any rough edges away.

The 2 x 30mm access holes in the top of the fin stub will have been pre-marked however for reference their centres should be located at 50mm and 300mm from the rear of the stub. Drill the rear hole through just the stub and the front hole through both the stub and the fuselage.

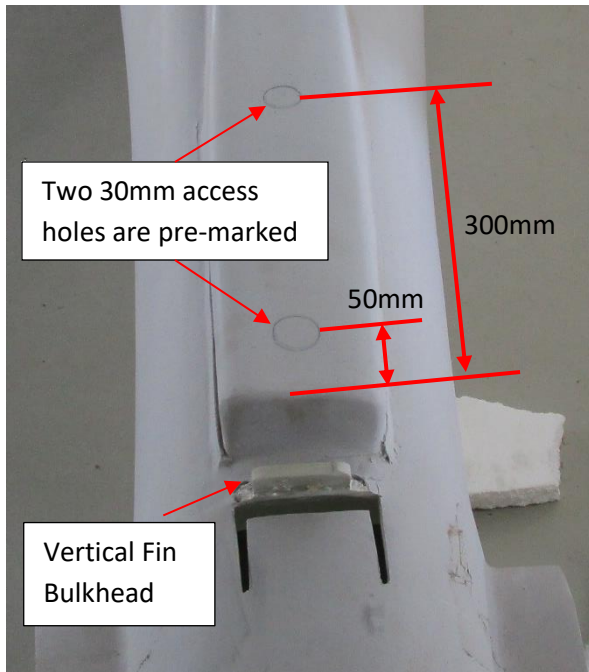

Upper fuselage penetrations

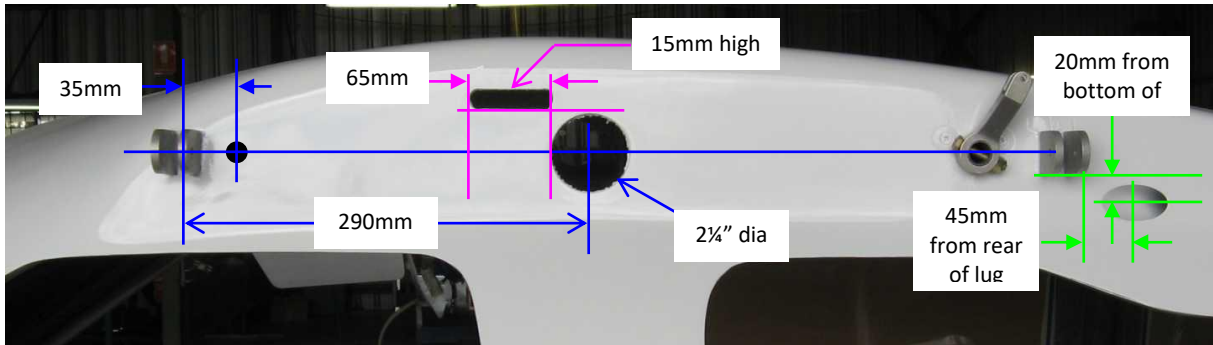

Mark a centreline between the bolt holes in the front and rear wing attach lugs: this will be the height of the centre of the fuel gauge opening.

Now double check the measurement marked "290mm" in the photos above and at right: measure in the wing root from the wing lug back to the centre of the gauge as shown at right and note the

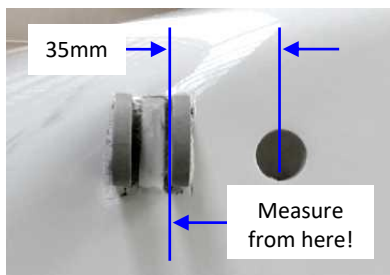
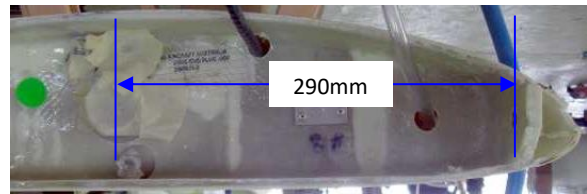

distance, then measure on the fuselage from the **inside (not the outside – see detail at left)** of the wing attach lug the exact same distance (which should be very close to 290mm) then mark and drill the pilot hole for the fuel gauge opening. Recheck your measurements and then use a 2 1/4" hole saw to cut the gauge hole: drill a pilot hole first.

Measure back 35mm from the inside of the wing lug and drill a 12mm hole for the stall warning tube as shown at left.

To mark the aileron cable slot, draw a line up from the front of the gauge opening and another line level with the top of the gauge opening, and then mark the slot at 65mm wide and 15mm high in **front** of the gauge opening. Drill both ends to 15mm and use a jigsaw to cut between the holes. File the top and bottom of the slot to a smooth and even finish.

Fuel line conduit, upper cabin

Mark a position 45mm behind and 20mm below the rearmost wing mounting lug on each side of the fuselage (position shown in the photo at the top of this page, the lines in green).

Drill a pilot hole that point and then enlarge to 32mm. Elongate each hole with a half-round file so that one length of the 32mm plastic conduit can be fitted into each hole at an acute angle with the inboard part of the conduit facing backwards into the cabin so that the fuel lines can be routed along the side of the cabin above the side window. Cut the outer end of the conduit so that it sits flush with the outside skin of the fuselage.

Fit each plastic conduit in place with 5 minute Araldite mixed with flock, seal around and wipe off any excess then leave to cure. Remove any rough edges, paying particular attention to the

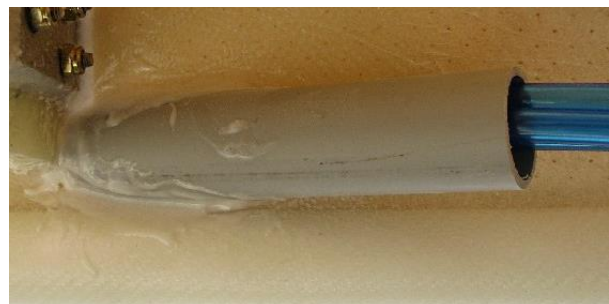



Pre-Paint>Fuselage>Prepare the fuselage> Procedure

inside of the conduit where the fuel lines will pass through – it is **very** important that the fuel lines will not be able to rub against any rough edges.

Fuel line conduit, rear bulkhead:

The fuel lines will be routed from the upper cabin conduits, through a sheath that will connect to the rear bulkhead conduits and down to the fuel header tank. This step just involves fitting the conduits to the rear bulkhead.

Mark a line on the rear bulkhead 350mm up from the top of the rear deck and another line 50mm in from the inside of each side of the fuselage as shown below:

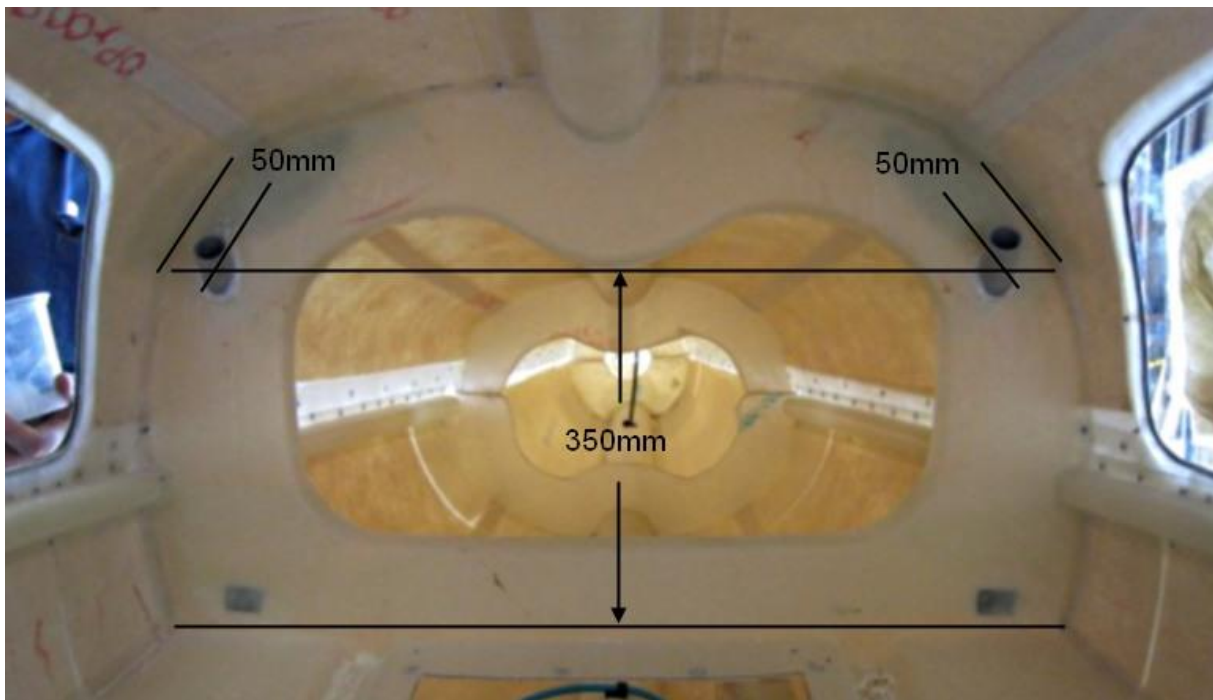

Drill a pilot hole at each point and then expand the holes in stages to 32mm. Elongate each hole with a half-round file so that the plastic conduit can be fitted at an approximate angle of 45 degrees as shown above. Leave enough length in front of the bulkhead to fit the sheath over the conduit and fix it in place with lock wire later in the build.

Fit each plastic conduit in place with 5 minute Araldite mixed with a little flock, seal around and wipe off any excess then leave to cure.

Remove any rough edges, paying particular attention to the inside of the conduit where the fuel lines will pass through – it is **very** important that the fuel lines will not be able to rub against any rough edges.

Cabin air vents

Cut a 60 x 44mm hole on each side of the lower forward fuselage.

The bottom of the hole should be 100mm above the bottom of the door opening and the fore and aft location should be centred on a vertical line drawn down from the rear of the cowl joggle, all as shown at right:

The air vent door surround can be flocked into place inside the fuselage with the hinge at the rear of each hole.

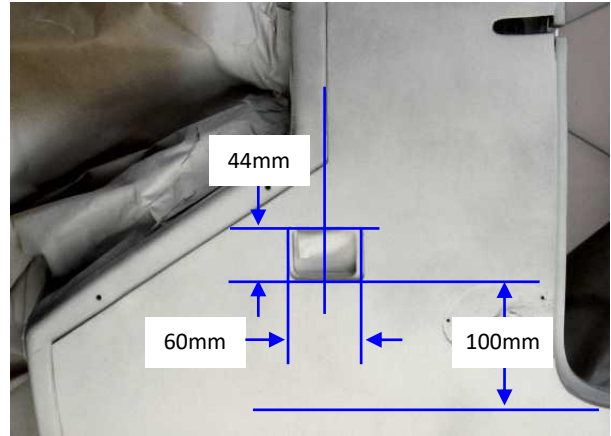

Cabin air vents

Assemble air vents and fit to fuselage.

ITEM	PART No.	DESCRIPTION	QTY
1	3A069B0D-1	FLANGE CABIN AIR VENT	1
2	3A069C0D-1	FLAP DOOR CABIN AIR VENT	1
3	3A069D0D-1	DOOR HINGE CABIN AIR VENT	1
4	M4 x 8 SCREW	M4 x 8 S/S BUTTON HEAD SCREW	1
5	PH0359N	METAL THREAD M4x25 BOLT	1
6	PH0209N	M4 NYLOC NUT	1

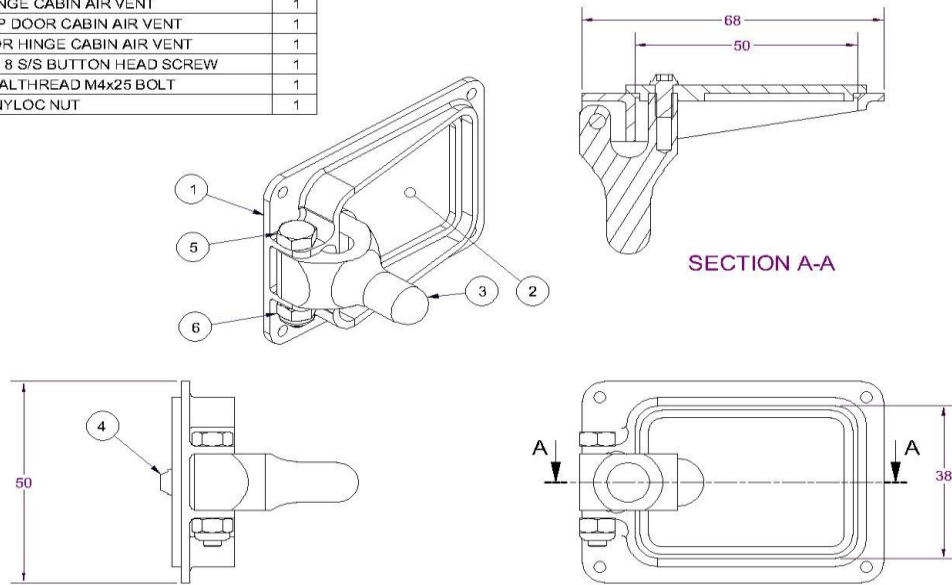

PROJECTION	DIMENSIONS IN MILLIMETRES	DO NOT SCALE	AVTECH P/L A.C.N. 010 786 973 HINKLER AIRPORT BUNDABERG 4670	THIS DRAWING IS COPYRIGHT AND MUST NOT BE COPIED WITHOUT THE CONSENT OF AVTECH PTY LTD	SCALE 1:1	1 ISS.	9/02/2006 DATE
MATERIAL AS DETAILED		APPR.		TITLE CABIN AIR VENT ASSY		DWG. No. 3A069A0D-1	SHEET 1 OF 1 A4

Rudder cable slot in console

At the left-hand front of the console there is an access slot for the rudder cable. The actual rudder cable slot needs to be marked directly below that slot but close to the floor with a slight upward angle at the front and cut as shown at right: the rear hole is drilled just above the floor while the front hole is 15mm above the rear hole – note that the blue line in the photo at right touches the top of the rear hole and the bottom of the front hole.



This slight upward angle allows a smooth cable run up to the rudder pedals. Drill each end of the slot to 15mm then use a jigsaw to cut the slot out. File the top and bottom of the slot to a smooth and even finish.

Wiring access slot in console

The slot at the top front of the console needs to be enlarged in length towards the front by 30mm.

Use a jigsaw to cut with and finish with a half round file.

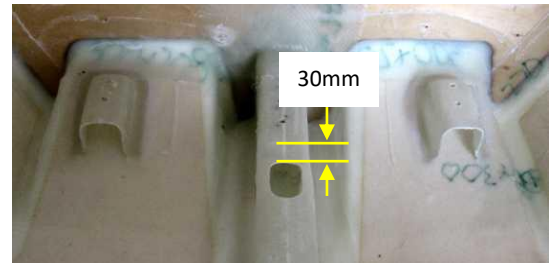

Cable access hole behind seats

Drill a 30mm hole in the console to the rear of the front seats as shows at right:

This will be used to assist cables over the main gear hump in the bottom of the fuselage and then filled with a rubber plug after the carpet has been fitted.



Cut the fuel header tank opening

Mark and cut an opening in the rear cabin step to access the area beneath, which is where the fuel header tank, fuel pump and fuel filter will be fitted.

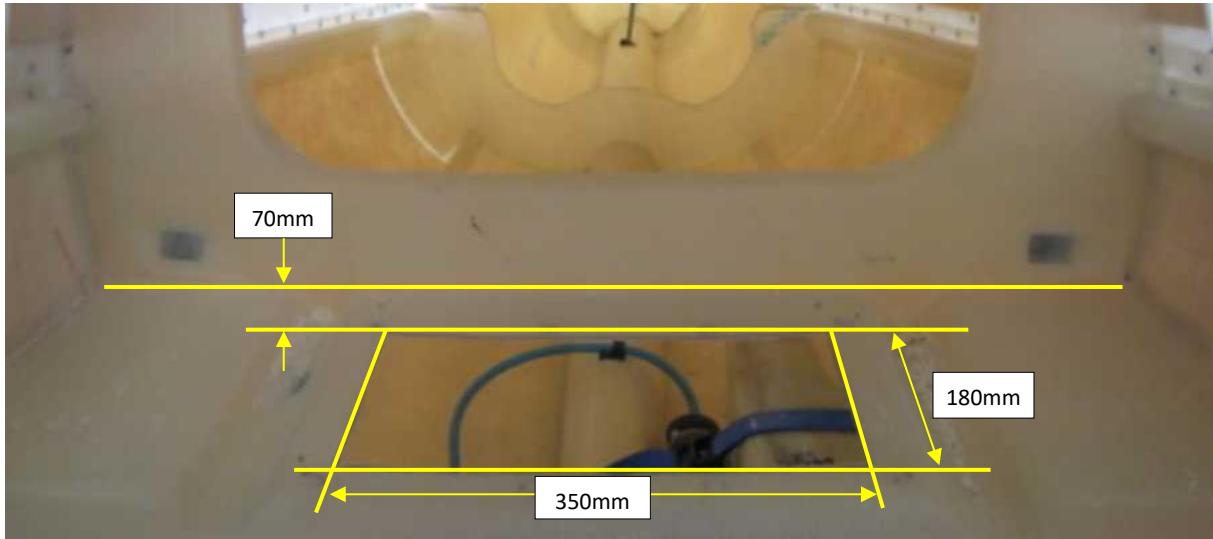

To make the opening, mark a 180mm by 350mm rectangle in the rear cabin step 70mm forward of the rear bulkhead as shown above, then cut the rectangle out using a jigsaw or hacksaw and remove it. Sand the edges smooth.

Centre the supplied 400mm x 220mm piece of 3 Layer Plate over the opening and drill 3/32" pilot holes: 1 on each corner and 1 midway on each long side, then use countersunk 3/32" rivets to pop-rivet captive nuts under each hole, first enlarging the screw holes to be slightly larger than the screws.

Drill a 20mm hole in the top of the lower longitudinal rib directly under the front edge of the opening that you have just made, then carefully chamfer the top and bottom edges of the hole – this is where the fuel line will run from the electric fuel pump forwards to the fuel tap as shown on the photo on the right, and there must be **no** roughness whatsoever in the hole that could later abrade the fuel line.

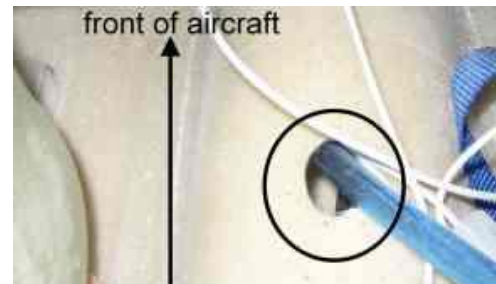

This completes the *Pre-Paint>Fuselage>Prepare the fuselage* task.